



Npower™ 30 to 130 kVA

Power Availability

THE NEW LEADER IN THREE-PHASE UPS PRODUCT



Npower



True Double Conversion

Exceptional Reliability

Unmatched Performance

High-Availability Configurations



WE'VE RE-INVENTED THE DOUBLE-CONVERSION UPS

Today's business processes cannot be interrupted. Businesses are buying and selling around the world, around the clock, every day. Even 40-hours-per-week operations need the reliability and maintainability of true 24x7 infrastructure during those 40 hours. That's why the cornerstone of your infrastructure should be the most reliable and advanced 3-phase UPS in its power range: the Liebert Npower.

Reliability Comes First

Reliability is a Liebert family tradition. All Liebert three-phase UPS products use double-conversion technology and all have field-proven critical bus Mean Time Before Failure (MTBF) in excess of one million hours.

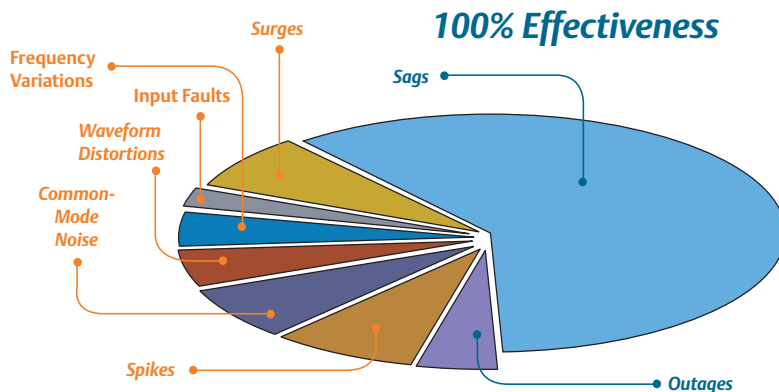

Double Conversion for 100% Protection

The UPS must support your business processes by providing clean, reliable uninterrupted power. A true double-conversion UPS is the only way to guard against the full spectrum of power disturbances. Anything less is a compromise.

Single-conversion UPS products (off-line, line-interactive and some self-proclaimed "online" topologies) cannot provide complete protection. Common-mode noise and frequency variations will pass straight through to the critical load. In addition, single-conversion products are vulnerable to input faults.

Output Waveform, 0-100% Step Load

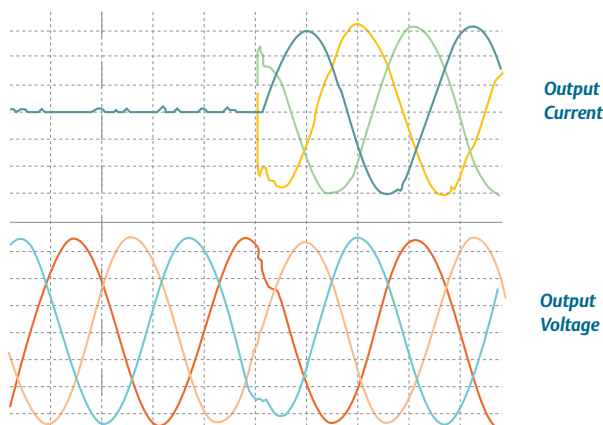

ActiveStar™ Controls for World-Class Performance

The Npower has truly spectacular operating performance, unmatched by any UPS in the industry. The all-digital ActiveStar controls are DSP-based and feature unique, patent-pending technology. The Npower makes fast adjustments to changing loads, including subcycle pulse-width corrections to keep the output voltage waveform nearly flawless.

Output voltage distortion (THD) typically measures less than 2.5%, under worst-case high-crest-factor, non-linear loads. The Npower is rugged enough to handle load branch faults, input faults, 100% step loads, PDU startup inrush and motor-load startup.

Exceptional Overload Performance

The combination of rugged inverter and continuous-rated static switch gives the Npower exceptional overload capability. By itself, the Npower inverter can supply up to 200% of rated capacity for 10 cycles and 150% for a full minute while maintaining a true sinusoidal waveform to the load. It can also handle up to 125% of rated capacity for ten minutes. Even during bolted faults, the ActiveStar controls are able to limit inverter output current to safe levels.

The internal static switch has two operating modes. For faults or transformer inrush currents, the static switch operates in the pulsed-parallel mode: the inverter remains connected while the static switch supplements inverter current with power from the bypass source. If the load continues to exceed the overload rating of the inverter, the static switch operates in the continuous-duty mode.

Overload capability of Npower UPS as a percent of nominal rating

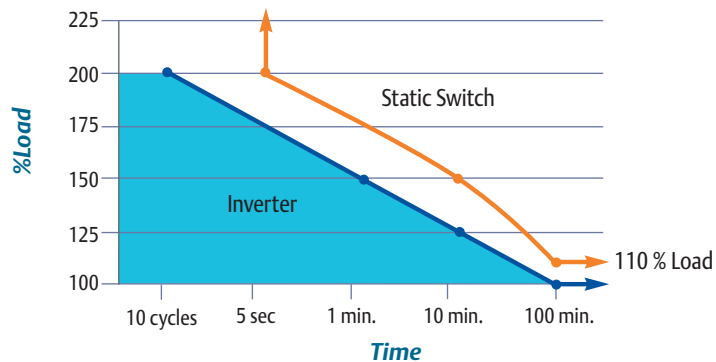

Rating of the internal static switch in amps

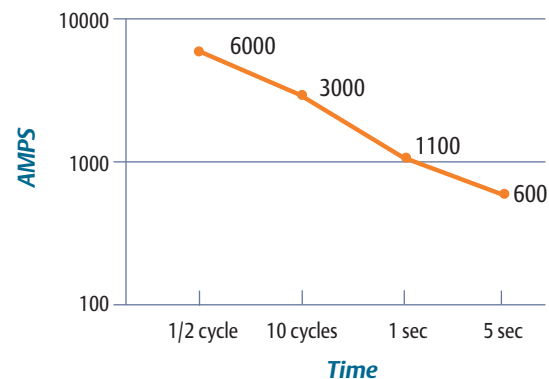

The overload curves above tell a remarkable story. The upper curve represents inverter capability as a function of overload versus time. The inverter remains on-line providing regulated power output at full voltage at every point of the overload/time curve. The lower curve represents the capabilities of the internal static switch. If the load moves beyond the line representing inverter capacity, the static switch will support the load to the full extent of its capacity.

The static switch has truly exceptional fault-clearing capacity, as shown in the second chart above. All Npower models have static switches rated for 6000 amps for the first half cycle, 3000 amps for 10 cycles, 1100 amps for one second and 600 amps for 5 seconds.

ACTIVESTAR™ CONTROLS FOR WORLD-CLASS PERFORMANCE

ActiveStar is a DSP-based control system that makes the UPS behave like a model citizen. ActiveStar controls the entire power train, including the Rectifier, DC Bus, Inverter and Static Switch. This makes the Npower very aware of its environment, and able to make intelligent adjustments.

Rectifier and DC Bus

The rectifier has an unusually large window of usable input voltage. Npower is able to operate at full load without discharging the batteries even when input voltage drops 20% below nominal. The feed-forward frequency control of the rectifier allows it to track the output of an unstable generator.

When the rectifier senses a large load step, it makes sub-cycle corrections to its phase angle and immediately begins drawing more power into the DC bus. This minimizes the effect of short-duration "hits" on the battery string and extends battery life.

At lower load levels, ActiveStar disconnects the input filter capacitors, to keep from presenting a leading power factor to the utility or to the standby genset. As the load increases, ActiveStar reconnects the capacitors, to optimize the input power factor and minimize harmonic currents reflected back to the input source.

Npower takes very good care of its batteries, with temperature compensated charging and other

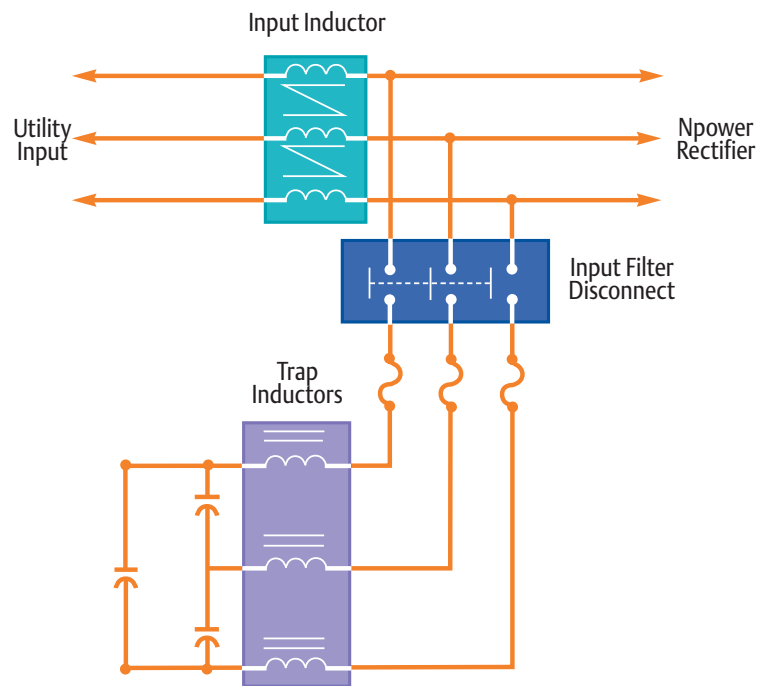

important features. As mentioned earlier, the rectifier responds quickly to load steps, reducing the number of short-duration battery "hits," which can greatly reduce battery life expectancy. In addition, the Npower can schedule regular battery self-test procedures, to verify that the battery string is capable of supporting the connected load.

The internal battery cycle monitor records the duration, kW and battery end voltage for every battery discharge event. This enables you to evaluate

battery performance and see how hard your batteries are working in this application.

The ActiveStar controls also optimize battery performance during longer discharge periods. During longer battery discharge events, the Npower gradually increases the low-battery shutdown voltage. This prevents the batteries from being discharged too deeply, and incrementally improves battery service life.

ActiveStar Inverter Elements

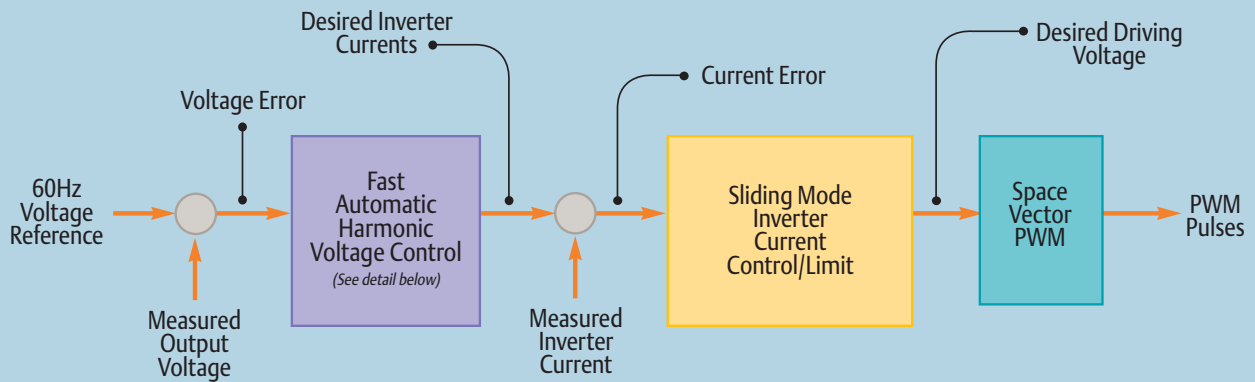

Inverter

The ActiveStar inverter controls have three elements, Voltage Harmonic Control, Sliding Mode Inverter Current Control, and Space-Vector PWM Inverter.

Voltage Harmonic Control compares the actual UPS output voltage to a 60Hz reference signal. It senses the content of load-generated harmonics and components introduced by unbalanced loads, and computes the compensating signals necessary to eliminate them. The Stabilizer then computes the amount of current necessary to force the voltage error to zero and ensure system stability.

The Sliding-Mode Current Control takes the output from the Stabilizer and determines the driving voltage necessary to make inverter currents follow what the voltage control desires. The Current Control corrects errors between desired and actual current in a single PWM pulse. On a bolted fault, this allows the inverter to limit its current at a safe level, rather than requiring immediate shutdown when bypass is not available. ActiveStar compensates once per PWM pulse (50 times per line cycle) compared to older UPS technology, which limits currents by gradually reducing its 60 Hz voltage reference once per line cycle (1/60 sec.).

Details of Fast Automatic Harmonic Voltage Control

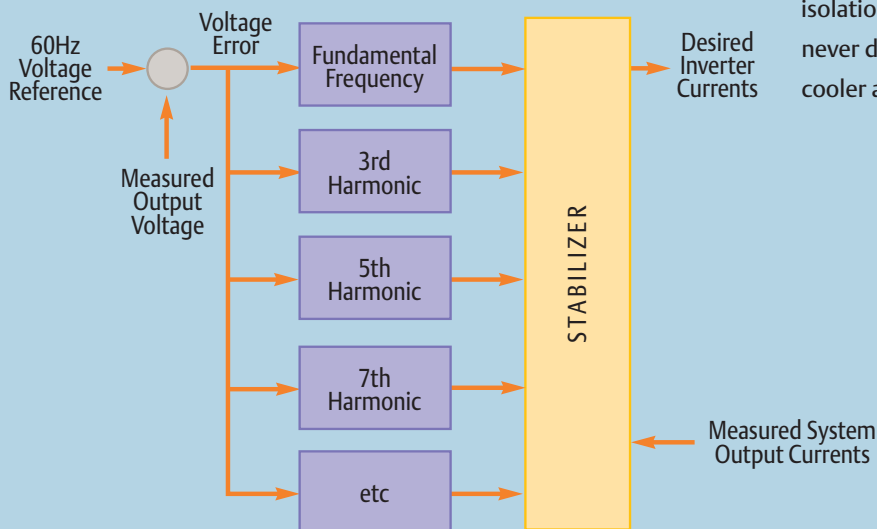

ActiveStar constantly monitors the harmonics being reflected by the customer's load equipment, and cancels them electronically. The inverter sources (compensates for) the harmonics as it sends pulses through the output isolation transformer. As a result, the output transformer never directly experiences the harmonics, and runs cooler and quieter.

NPOWER: THE BEST VALUE IN A MID-RANGE UPS

The Npower gives you more UPS for about the same initial cost as lesser products. Furthermore, the Npower will usually cost significantly less over the lifetime of the product.

The value comes from several elements: exceptional protection, higher efficiency, lower installation, maintenance and operating costs, smaller total system footprint and more standard features.

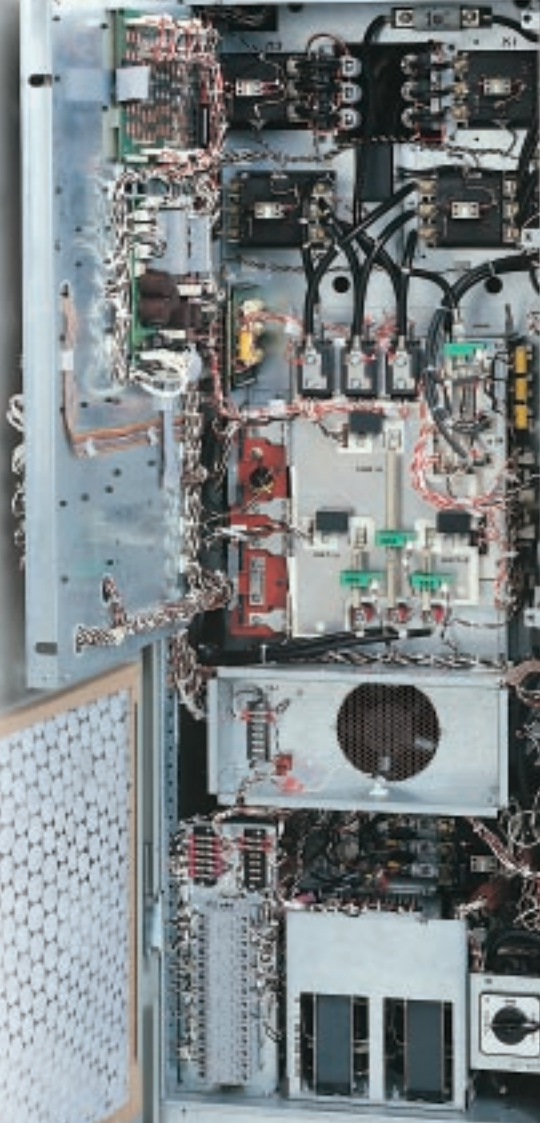

Higher Efficiency in Real-World Applications

Critical applications require a UPS to have an input filter (to reduce input current distortion) and an output isolation transformer (to isolate your critical load), while powering non-linear (high-crest-factor) loads at less than the rated capacity of the UPS.

The fully equipped Npower has excellent efficiency – typically between 92% and 93.5% – while powering high-crest-factor loads between 50 and 100% of its rated capacity. Furthermore, the input power factor is exceptionally high, typically 0.95 to 0.96 for models with 480 VAC input.

In this power range (up to 130 kVA), the only way to exceed 93.5% efficiency is to leave out something important. Some competitors omit the output isolation transformer; others put your critical load at risk with their single-conversion UPS products. Only you can decide if the claimed savings justify the risk.

Full-Featured Communications Options

The Npower is fully compatible with the Liebert OpenComms™ system. The OpenComms Network Interface Card (NIC) enables the Npower to communicate with a web browser via HTML, to a Network Management System via SNMP, or to a building management system using Modbus. The OpenComms Nform™ software provides centralized monitoring of distributed devices. Liebert's MultiLink™ shutdown software protects critical data on servers. Liebert's SiteScan WEB™ is an enterprise-class critical monitoring system. *See page 11 for details.*

Easy to Purchase and Install

This UPS can be as simple as you need it to be. Ask your sales representative about our complete-system packages. With battery cabinet, maintenance bypass cabinet and Slim-Line power distribution unit, the Npower is a bolt-together system.

Power cables and control wiring harnesses between cabinets are included, saving time and cost. All cabinets have casters and leveling feet, to further simplify installation.

Smallest Complete-System Footprint

The Npower achieves a small footprint despite being a full-featured, double-conversion UPS. Furthermore, Liebert understands that real systems have battery cabinets, maintenance bypass cabinets and some type of power distribution cabinets. Therefore, our design goal was to build complete systems, in all their variant forms, in the smallest practical size consistent with good engineering practices. Consider this:

- No size penalty for 208 VAC input or output. For each kVA rating, all input voltages and all output voltages fit in the same size package.
- Input isolation and bypass isolation transformers fit inside the same package.
- Battery trays slide out the front for maintenance.
- Bypass isolation transformers can also be built into your maintenance bypass cabinet.
- The Slim Line distribution unit adds just 10 inches to the width of the UPS module, but gives you 42 or 84 poles.

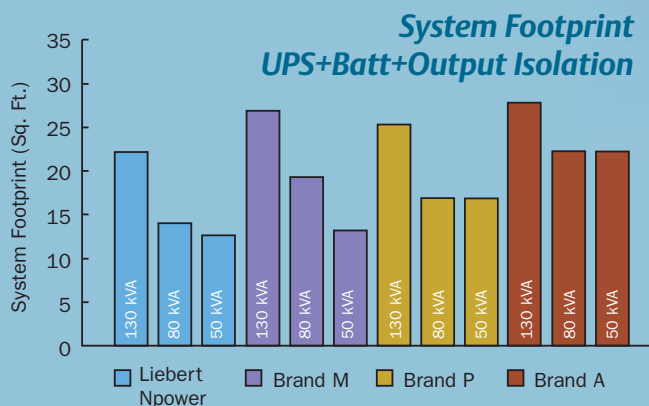

NPOWER: CONFIGURATIONS FOR ANY APPLICATION

Input and Output Configurations

Single or Dual Input:

- Single-input UPS products are often favored in this power range (30 to 130 kVA). This is the simplest and lowest-cost solution. It features a single input bus, with both the input and bypass circuits fed from the same external feeder breaker.
- Dual-input UPS products have separate busses for the rectifier input and the bypass circuit. This adds a measure of fault tolerance, because a single external breaker failure will not cause the load to fail. It also adds cost: an additional input feeder breaker and more input cabling.

One-Line Diagram Single-Input with delta-wye output

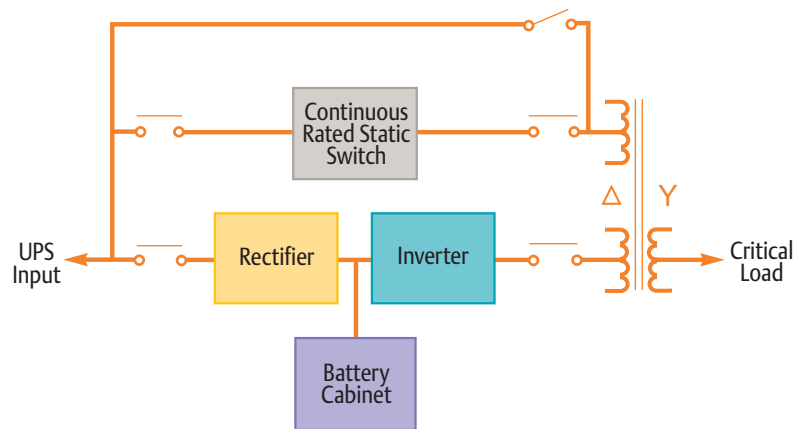

Isolated or Non-Isolated Neutral

Proper grounding is essential for reliable UPS operation. The installing contractor must ensure the integrity of the ground and neutral connections and select the UPS best suited for the facility.

The Npower can be ordered with or without an isolated bypass neutral. With an isolated neutral, the UPS contains an internal bypass isolation transformer and does not require an

input neutral brought in from the service entrance. Shown below are the various configurations and their applications:

- A non-isolated neutral is the lowest-cost option, but requires the installing contractor to pull a neutral line from service entrance. This configuration can support three-wire or four-wire-plus-ground loads where the input and output voltages are the same.

- An isolated neutral with Delta-Wye isolation transformer is able to support 3-wire or 4-wire-plus-ground loads of any sort. The output is phase-shifted 30 degrees from the input.
- An isolated neutral with Wye-Wye isolation transformer is able to support 3-wire loads at the supply voltage. The output is in phase with the input. This configuration cannot support 4-wire loads.

Specific Configurations

Single Input Configurations

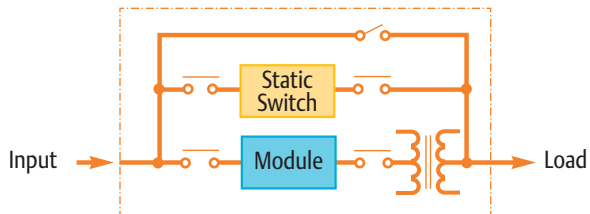

Configuration A & B With Non-Isolated Bypass

This configuration is for applications where the input is 4-wire plus ground. Output voltage must be the same as the input voltage. This configuration cannot have the neutral-to-ground bond at the UPS module. The output is 4-wire plus ground. The output is in phase with the input.

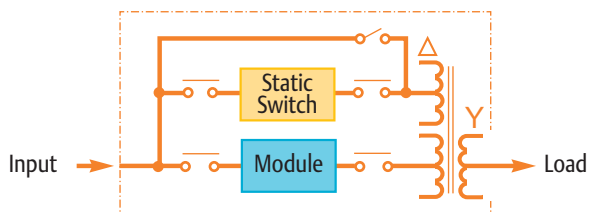

Configuration D & E With Load Neutral Isolation

This configuration is for applications where the UPS provides isolation on both the inverter and the bypass circuit. This configuration has the neutral-to-ground bond at the UPS module. The input is 3-wire plus ground, and the output is 4-wire plus ground. The output is 30° phase-shifted from the input.

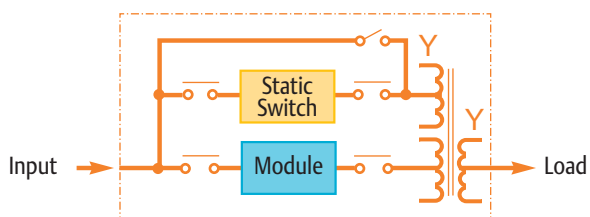

Configurations R & S With Load Neutral Isolation

This configuration is for applications with 480 VAC input and 480 VAC output, and there are no line-to-neutral loads. The UPS provides isolation on both the inverter and the bypass circuit. This configuration has the neutral-to-ground bond at the UPS module. The input and output are both 3-wire plus ground. The output is in phase with the input.

Dual Input Configurations

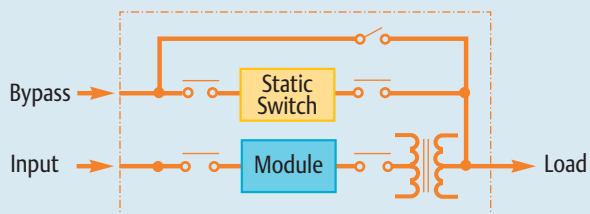

Configuration A & B: With Non-Isolated Bypass

This configuration is for applications where the bypass input is 4-wire plus ground. Output voltage must be the same as the bypass input voltage. The rectifier input is 3-wire plus ground. The output is 4-wire plus ground. The output is in phase with the bypass input.

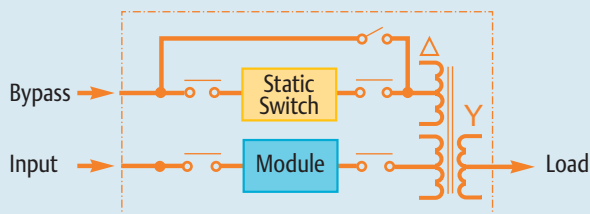

Configurations D & E: With Load Neutral Isolation

This configuration is for applications where the UPS provides isolation on both the inverter and the bypass circuit. This configuration has the neutral-to-ground bond at the UPS module. The rectifier and bypass inputs are 3-wire plus ground, and the output is 4-wire plus ground. The output is 30° phase-shifted from the bypass input.

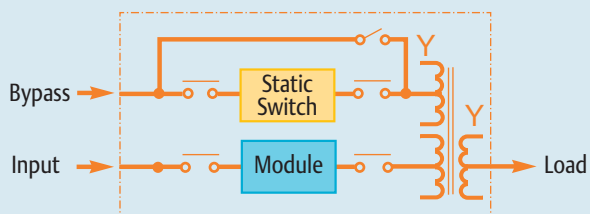

Configurations R & S: With Load Neutral Isolation

This configuration is for applications with 480 VAC bypass input and 480 VAC output and there are no line-to-neutral loads. The UPS provides isolation on both the inverter and the bypass circuit. This configuration has the neutral-to-ground bond at the UPS module. The rectifier and bypass inputs and the output are all 3-wire plus ground. The output is in phase with the bypass input.

Specifications

UPS Rating		Battery	Maximum Heat	Dimensions (WxDxH) ²		Approximate Weight ³	
kVA	kW	Nominal (VDC)	Dissipation At Full Load (BTU/Hr) ¹	Inches	MM	Pounds	KG
30	24	480	8,500	31.7x32.5x71	805x825x1800	2,200	1,000
40	32	480	11,000	31.7x32.5x71	805x825x1800	2,200	1,000
50	40	480	14,000	31.7x32.5x71	805x825x1800	2,200	1,000
65	52	480	18,000	39.4x32.5x71	1000x825x1800	2,700	1,225
80	64	480	22,000	39.4x32.5x71	1000x825x1800	2,700	1,225
100	80	480	26,000	49.2x32.5x71	1250x825x1800	3,800	1,725
130	104	480	33,000	49.2x32.5x71	1250x825x1800	3,800	1,725

Matching Battery Packs

Model	Battery Time In Minutes/UPS kVA							Dimensions (WxDxH)		Weight ³	
	30	40	50	65	80	100	130	Inches	Millimeters	Lb	Kg
1FJ	11	7						25x32.5x71	635x825x1800	1,600	725
1HJ	21	14	10	5				25x32.5x71	635x825x1800	1,800	815
1LJ	28	19	14	8	5			25x32.5x71	635x825x1800	2,350	1,065
1MJ	35	25	18	12	8	5		25x32.5x71	635x825x1800	2,350	1,065
1PJ	54	38	28	20	15	10		25x32.5x71	635x825x1800	3,000	1,360
1PJ							7	49x32.5x71	1000x825x1800	3,350	1,520
1RH	66	46	35	25	19	13	9	49x32.5x71	1000x825x1800	3,900	1,773
1UH	74	52	40	30	22	17	11	49x32.5x71	1000x825x1800	4,250	1,932
1WH	109	77	56	41	33	25	17	49x32.5x71	1000x825x1800	5,450	2,477
2PJ		100	74	50	38	28		2 x 25x32.5x71	(2x) 635x825x1800	6,000	2,720
2PJ							20	2 x 49x32.5x71	(2x) 1000x825x1800	6,700	3,040
2RH			80	61	46	35	26	2 x 49x32.5x71	(2x) 1000x825x1800	7,800	3,545
2UH			94	69	52	39	31	2 x 49x32.5x71	(2x) 1000x825x1800	8,500	3,864
2WH				102	78	61	40	2 x 49x32.5x71	(2x) 1000x825x1800	10,900	4,955

¹ Heat dissipation figures are for worst-case configurations (including 208 VAC, input and output), supporting 100% load at rated power factor.

² Dimensions and weights do not include battery or maintenance bypass cabinets.

³ Weights are for heaviest models, with 208 VAC input.

Standard Features

Like other Liebert UPS products, the Npower includes some features that are options (or not available) for some competitors:

- True double-conversion topology, for protection against 100% of power disturbances.
- Internal bypass switch enables you to isolate the UPS for maintenance.
- Continuous-duty static switch performs in pulsed-parallel mode for supplying fault current and momentary overloads, and can operate continuously for longer-duration events.
- Internal output isolation transformer protects your critical load from common-mode noise and harmful DC offsets. In some configurations, it provides a separately derived source, to support 4-wire loads without having to pull a neutral line from the service entrance.
- Automatic input filter disconnect isolates the input filter capacitors at light loads to avoid presenting a leading power factor to the utility or backup generator.
- Backlit LCD graphic display enables easy navigation between the graphic mimic screen and the menu screens.
- Event Log can display up to 512 time-and-date-stamped alarm events.
- Battery self-test helps verify the battery's readiness to carry the critical load.
- Battery temperature-compensated charging prevents overcharging in high ambient operating temperature or undercharging in cold weather.
- Battery Cycle Monitor records up to 132 battery discharge events.
- Battery Time Remaining feature displays backup time remaining at present connected load.
- On-generator battery charge limit reduces recharge current until the utility AC power is restored.
- Front-panel control of all configuration and field-adjustment options simplify installation and maintenance.
- Top-and-bottom cable entry gives the installer more options for equipment location.
- Two-hole bus bar landing space and accessible terminal blocks for options can simplify installation.
- Casters under the unit are helpful when a forklift is not readily available.
- One-button startup for simpler operation.

General Specifications

Options and Accessories

- Matching valve-regulated lead-acid battery packs
- Matching maintenance bypass cabinet
- Matching bolt-on power distribution unit, with one or two 42-pole panels
- Input filter/power factor correction
- Internally mounted input isolation transformer
- Load Bus Sync™ Systems
- Flooded rack-mounted battery systems
- SNMP, SiteScan and other communications interfaces:
See sidebar “Communications Options”
- Remote monitor panel
- Alarm status contacts
- Customer alarm inputs

Input

Voltage: 208, 220, 240, 480 or 600 VAC, 60 Hz, 3-phase, 3-or 4-wire plus ground

Voltage Range: +10, -15% (no battery discharge at -20%)

Frequency Range: 60 Hz, ± 5 Hz

Current Distortion: 10% maximum reflected THD at full load with optional input filter. 30% THD without filter.

Current Limit: 115% of full load input current

Current Walk-in: 20 seconds to full load.

Power Factor: Up to 0.96 lagging at full load with optional input filter. 0.80 lagging minimum at full load without optional input filter.

Surge Protection: Sustains input surges without damage, per criteria listed in ANSI C62.41-1980, A & B (IEEE 587).

Output

Voltage: 208, 220, 240, 480 or 600 VAC, 60 Hz, 3-phase, 4-wire plus ground.

Voltage Adjustment Range: $\pm 5\%$.

Voltage Regulation:

$\pm 0.5\%$ for balanced load

$\pm 1.0\%$ for 100% unbalanced load.

Dynamic Regulation: $\pm 2.5\%$ deviation for 100% load step. $\pm 1\%$ for loss or return of AC input.

Transient Response Time: Recover to steady state within 1 cycle.

Voltage Distortion: For linear loads, 1% THD. Less than 2.5% THD for 100% nonlinear loads (3:1 crest factor) without kVA/kW derating.

Phasing Balance: $120^\circ \pm 0.5^\circ$ for balanced load. $120^\circ \pm 1^\circ$ for 100% unbalanced load. Frequency Regulation: $\pm 0.1\%$.

Load Power Factor Range: 1.0 to 0.7 lagging without derating.

Overload: 125% of full load for ten minutes. 150% for one minute with true sinusoidal waveform.

Environmental

Operating Temperature: 0° to 40°C (UPS), 20° to 30°C (battery)

Non-Operating Temperature: -20°C to 70°C .

Relative Humidity:

0-95% non-condensing

Operating Altitude: Up to 6,600 feet (2000 meters) without derating.

Acoustical Noise: Less than 65 dBA typical, measured 1 meter from the unit.

Standards

ETL Listed to UL 1778 and UL 924 UPS standards, and CSA certified.

Meets current requirements for safe high-performance UPS operation.

Communications Options

The Npower will support any communications strategy. The OpenComms™ family of products help you get the most from your existing network. The **OpenComms Network Interface Card (NIC)** supports three interfaces:

- Web browser, via HTML,
- SNMP interface for use with OpenComms Nform™ or another Network Management System, and
- Modbus, to interface with your existing building management system.

The **OpenComms Nform** software is a versatile SNMP package. It provides:

- Centralized monitoring of all Liebert SNMP-enabled devices,
- Event and alarm management,
- Adaptable and configurable viewer,
- Integration of third-party SNMP devices through custom Liebert services.

Npower is also compatible with Liebert's SiteScan™ family of enterprise monitoring systems. In particular, **SiteScan WEB** allows users easy access from nearly anywhere, with:

- Single and multi-site applications,
- Full-featured graphical user interface via the Web,
- Event management trending and reporting,
- User authentication and unit control,
- Full ASHRAE BACnet compatibility.

Npower can be used with a variety of other communications products including MultiLink™ shutdown software, SiteLink integrator modules, Site TPI (to integrate signals from non-Liebert equipment), Site I/O (to integrate sensors and contacts), contact-closure alarm panels, and more. Contact your Liebert sales representative for details.

WE HELP YOU GET IT RIGHT — RIGHT FROM THE START.

Npower™ 30 to 130 kVA

Power Availability

For over 35 years, Liebert has been providing tailored solutions for protecting the operation of critical electronic systems in a variety of industries. From laboratories to industrial business networks, we've used our expertise to tailor the right products, site monitoring and global service capabilities into a variety of specific solutions.

Liebert's years of experience and knowledge of leading edge technologies enables us to truly understand your needs — both in terms of overall reliability and specific areas of equipment protection. Whether it's a new or existing facility, we listen to you and your preferences to help us develop solutions that are right for your application.

We recognize that each situation has its own unique requirements and are better prepared than any other manufacturer to deliver the right level of reliability at the right price. We do this through a combination of knowledge, experience, product selection and service capability.

Someone Nearby To Help Before And After The Sale

Specifying a high-availability facility support system requires someone who is knowledgeable in all phases of environmental and power protection. Knowing where to turn for ongoing maintenance or service is just as important.

One of the many things that differentiates Liebert from others in our business is local presence. We have the most extensive sales and service network in the world. Liebert's extensive network of technical sales associates, backed by the industry's largest service organization, enables us to respond quickly to customer needs.

No matter where your needs for protecting the infrastructure of your facility are heading — Liebert is the one source that can deliver the right solution.

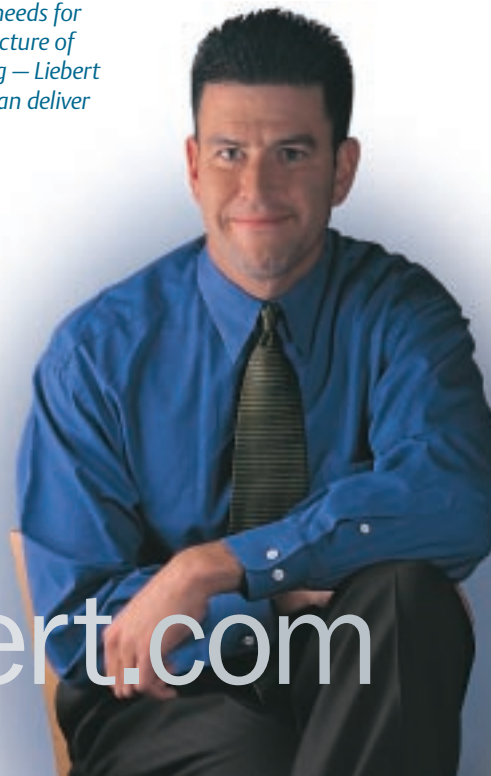

LIEBERT CORPORATION

1050 DEARBORN DRIVE
P.O. BOX 29186
COLUMBUS, OHIO 43229
800.877.9222 PHONE (U.S. &
CANADA ONLY)
614.888.0246 PHONE (OUTSIDE U.S.)
614.841.6022 FAX

VIA LEONARDO DA VINCI 8
ZONA INDUSTRIALE TOGNANA
35028 PIOVE DI SACCO (PD)
ITALY
39 049 9719 111 PHONE
39 049 5841 257 FAX

23/F ALLIED KAJIMA BLDG.
138 GLOUCESTER ROAD
WANCHAI
HONG KONG
852 2 572 2201 PHONE
852 2 831 0114 FAX

LIEBERT WEB SITE

<http://www.liebert.com>

24 X 7 TECH SUPPORT

1 800 Liebert (543 2378) PHONE
614 841 6400 (OUTSIDE U.S.)

While every precaution has been taken to ensure accuracy and completeness in this literature, Liebert Corporation assumes no responsibility, and disclaims all liability for damages resulting from use of this information or for any errors or omissions.

© 2002 Liebert Corporation. All rights reserved throughout the world. Specifications subject to change without notice. All names referred to are trademarks or registered trademarks of their respective owners.

® Liebert and the Liebert logo are registered trademarks of the Liebert Corporation.

® Keeping Business in Business is a registered trademark of the Liebert Corporation.

The Emerson logo is a trademark and service mark of Emerson Electric Co.

SL-24529 (R8/02)
Printed in USA



www.liebert.com